

SMP-FLA-4

Forklift Attachment for 4" Forks (Sold in Pairs)

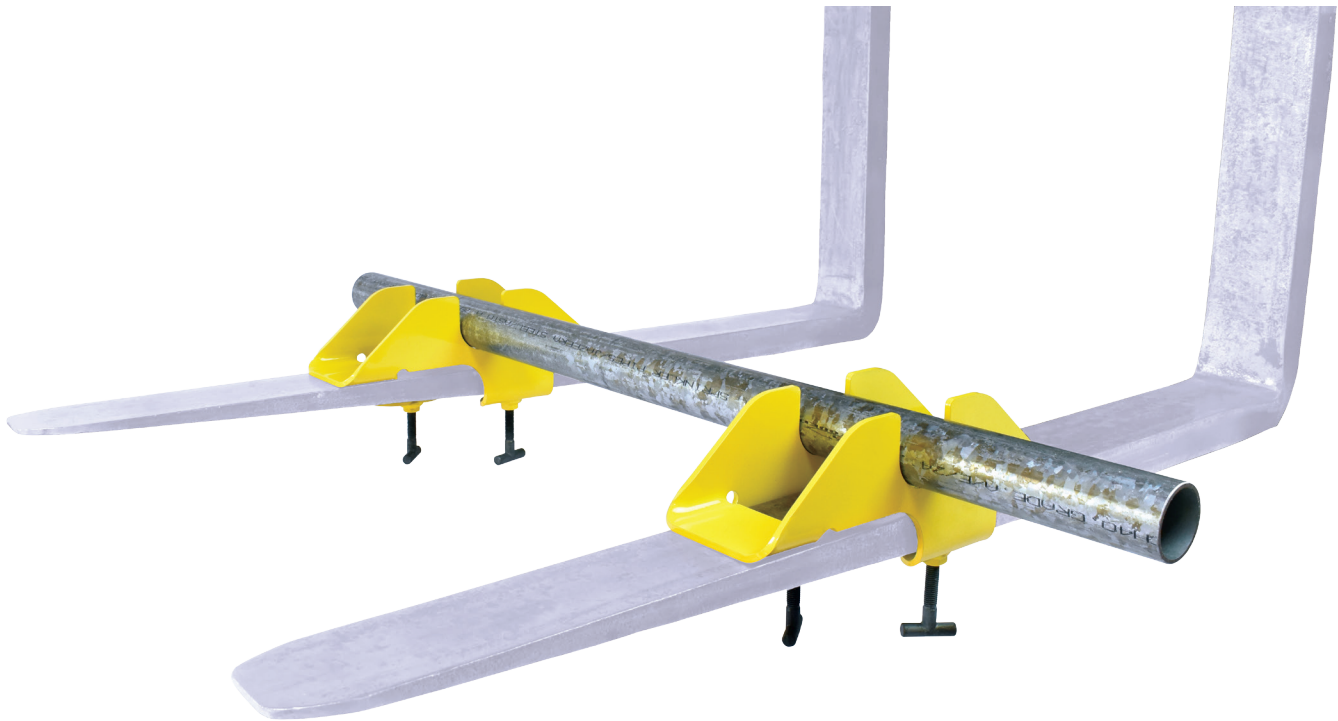

The SMP-FLA-4 forklift attachment is ideal for lifting, transporting or payout of materials stored on a reel. The heavy-duty T-Handle locking mechanism ensures this reel roller will hold steady regardless of pull strength or forklift driver. Designed to work with 4" wide forks, the SMP-FLA-4 attachment (sold in pairs) features 1/4" laser-cut steel construction with a powder coated finish, and a 48" arbor support bar that must be used to support the reel.

Features:

- Sold as one (1) SMP-FLA-4 set (reel sold separately)
- Set includes one (1) 48" arbor support bar (must be used)
- For lifting, transport, or pay-out of materials stored on a reel
- Product weight: 9 lbs. each (yellow part); 15 lbs. (arbor)
- Maximum weight capacity: 3,000 lbs
- Maximum reel diameter: Forklift model dependant
- Maximum reel width: See forklift specifications
- Frames constructed of 3-gauge steel (1/4" laser cut)
- T-Handle locking mechanism
- Powder coated finish
- Outside dimensions: 6.25" H x 5" W x 14.75" L (each)
- Made in the USA

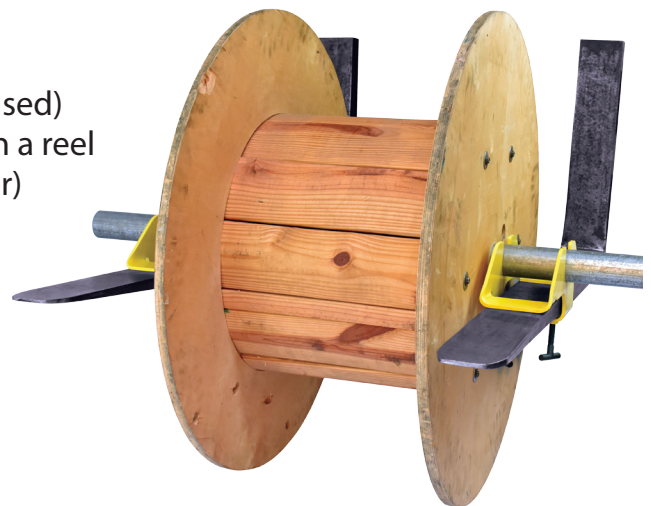

P.O. Box 12017 Marina del Rey, CA 90292
Phone: 310-822-6290 Fax: 310-306-9343
Email: info@spoolmaster.com
Visit us online at www.spoolmaster.com



SMP-FLA-4

Forklift Attachment for 4" Forks (Sold in Pairs)

Dimensions Per Attachment:

Height: 6.25" (15.875 cm)
Width: 5" (12.7 cm)
Length: 14.75" (37.5 cm)
Weight: 9 lbs (4.08 kg)

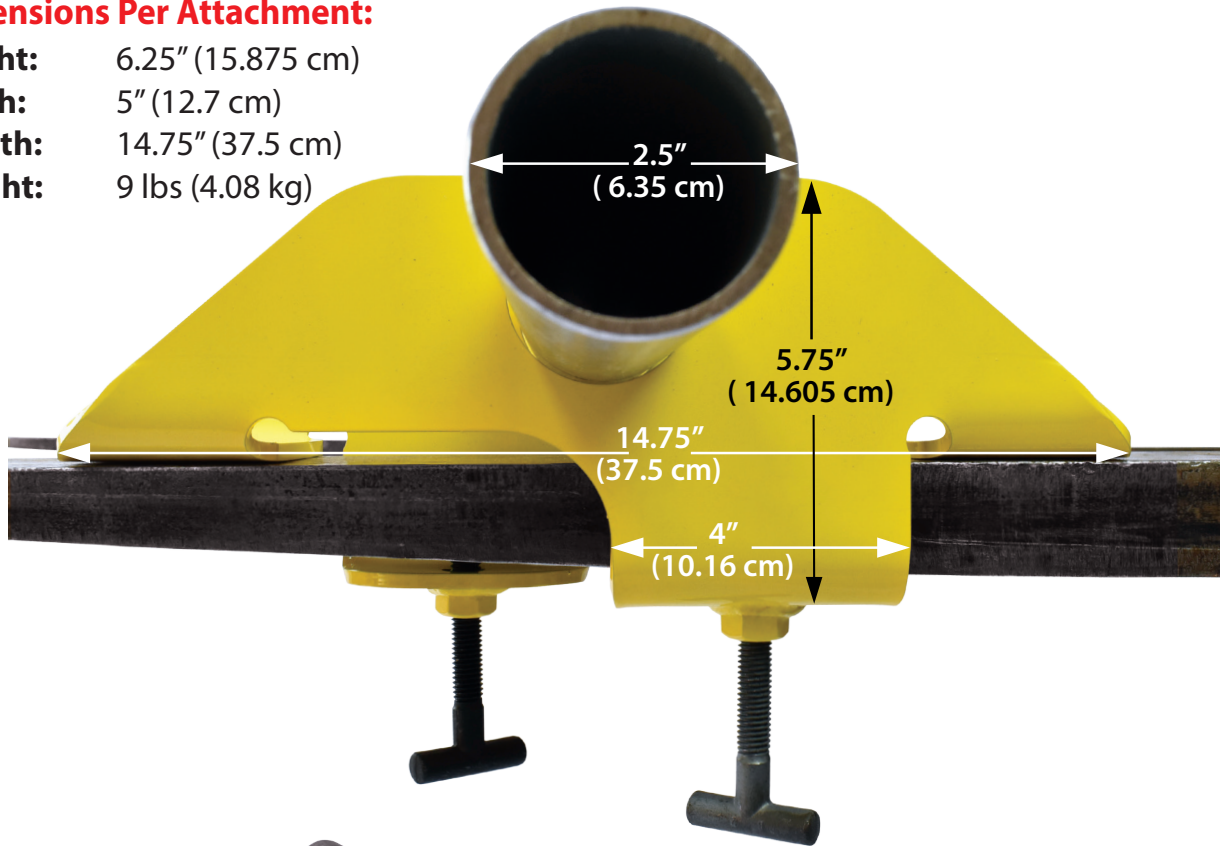

P.O. Box 12017 Marina del Rey, CA 90292
Phone: 310-822-6290 Fax: 310-306-9343
Email: info@spoolmaster.com
Visit us online at www.spoolmaster.com

