

## Clevis Pin

All clevis pins are manufactured from heat treated 416 stainless steel to provide superior strength and wear. Hardness is between 37-40 Rc.

The DCD Clevis Pin is a shouldered type of pin rather than a simple straight pin without any head. This design greatly improves the strength of the clevis by not allowing side loads to spread the clevis opening.

The clevis and pin are precision machined so that both surfaces contact simultaneously and therefore lock in place when screwed tight. By using the recommended torque, the pin is secured with the corresponding preload, ensuring it won't come loose. Tensile loads are carried by the pin shoulder and transferred to the swivel body, and therefore no tensile load is carried by the thread.

The hardened clevis pin also resists wear much better than conventional clevis pins. During operation there is a constant rubbing between the surface of the clevis pin and the attached item. A hard surface decreases the wear on the pin as well as increasing the strength of the pin.

Finally, the larger diameter of the shoulder will decrease wear on the attached item. If this happened to be a wire rope, a conventional pin would cause that rope to bend in a very tight radius, affecting the life of each strand. The larger DCD pins increase that radius and also increase the life of the wire.

Products 1-1/4" dia. and less are supplied with slotted clevis pins; those greater than 1-1/4" are supplied with hexagon socket clevis pins. This is based on consumer preference. Either slotted or hexagon pins are available for most sizes, but must be requested at time of ordering if not standard.

Because the DCD Clevis Pin is a precision machined product specifically designed to fit the clevis, field substitution with any other pins is not recommended. Doing so may cause serious danger to operators and equipment and will immediately void any warranty or liability for the product.

All Clevis Pin kits contain two pins.

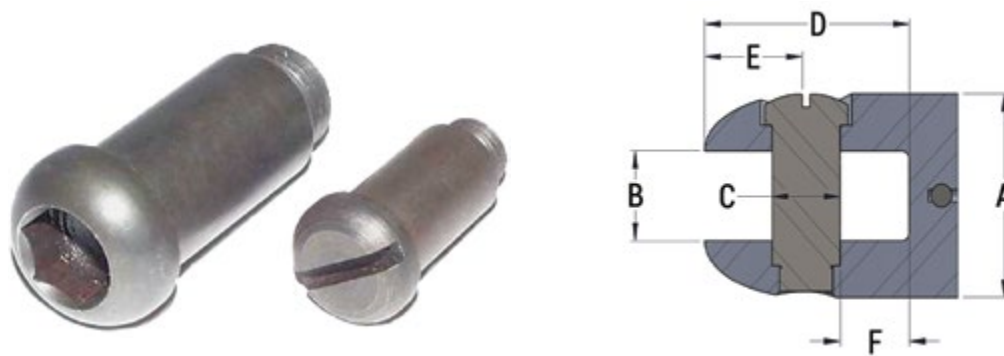

Slotted Part No.	Hexagon Part No.	Hex Key Size	A	B	C	D	E	F	Recommended Torque	Corresponding Preload
00005-SLT*	-	-	5/8"	9/32"	3/16"	11/16"	1/4"	11/32"	1.0 ft-lb	366 lb
00010-SLT*	00010-HEX	7/32"	7/8"	3/8"	5/16"	31/32"	7/16"	3/8"	2.5 ft-lb	600 lb
00015-SLT*	00015-HEX	1/4"	1"	13/32"	3/8"	1-3/32"	1/2"	13/32"	5.4 ft-lb	1,040 lb
00020-SLT*	00020-HEX	1/4"	1-1/4"	17/32"	13/32"	1-9/32"	17/32"	9/16"	6.7 ft-lb	1,280 lb
00025-SLT	00025-HEX*	5/16"	1-3/8"	9/16"	1/2"	1-3/8"	5/8"	1/2"	16.7 ft-lb	2,667 lb
-	00027-HEX*	5/16"	1-1/2"	19/32"	1/2"	1-9/16"	11/16"	5/8"	16.7 ft-lb	2,667 lb
00030-SLT	00030-HEX*	3/8"	1-5/8"	11/16"	5/8"	1-23/32"	3/4"	21/32"	25.0 ft-lb	3,000 lb
00035-SLT	00035-HEX*	3/8"	2"	25/32"	11/16"	2-1/16"	15/16"	25/32"	50.0 ft-lb	5,333 lb
-	00037-HEX*	3/8"	2-1/4"	7/8"	3/4"	2-3/8"	1-1/8"	3/4"	75.0 ft-lb	7,200 lb
-	00040-HEX*	3/8"	2-3/8"	1-1/32"	7/8"	2-25/32"	1-3/16"	1-5/32"	100.0 ft-lb	8,000 lb
-	00045-HEX*	3/8"	3"	1-3/16"	1-1/8"	3-5/8"	1-1/2"	1-9/16"	190.0 ft-lb	13,029 lb
-	00050-HEX*	1/2"	3-3/4"	1-1/2"	1-1/4"	4-1/4"	1-7/8"	1-3/4"	250.0 ft-lb	15,000 lb

\* Standard Clevis Pin type supplied in most products.  
Note: Marine grade versions are available; made to order.

## Line Swivel

DCD Line Swivels are typically constructed with a thrust bearing for tensile load and a radial bearing for bending load. They combine a high safe working load with a compact design. All sizes incorporate an oil seal and are manufactured from high strength stainless steel.

DCD Locking Line Swivels are typically constructed with a bronze thrust bearing for tensile load and a radial bearing for bending load. The bronze bearing will rotate up to a portion of the safe working load before locking. Once past this point, rotation will only occur when pulling tension is relieved.

Sizes 00505-020 and larger are supplied with a grease point for lubrication. This is particularly useful in overhead applications where high speed rotation is possible.

All sizes of both types are pull tested to verify the 3:1 safety factor.

Sizes 00505-025 and larger are supplied with hexagon clevis pins. Smaller sizes have slotted clevis pins. Under no circumstances should alternate clevis pins be used.

Permanent peen marking is now standard on all line swivels and material traceability for all batches produced.

Note: Line Swivels are not designed to run around bull wheels and severe damage or injury may be incurred if this is done.

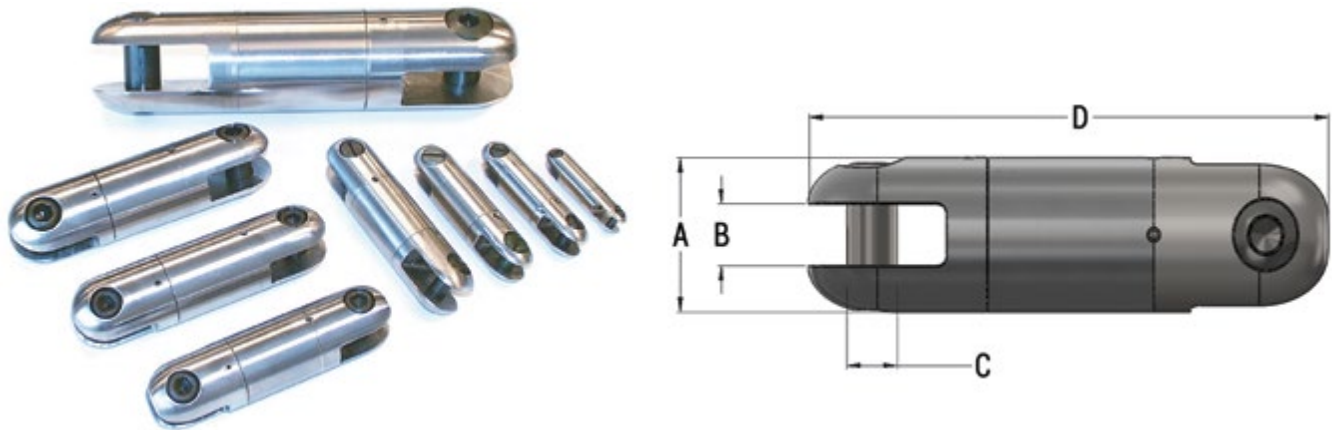

Part No.	Locking Part No.	3:1 Safe Working Load	5:1 Safe Working Load	A	B	C	D	Weight	Replacement Clevis Pin
00505-005	-	750 lb	450 lb	5/8"	9/32"	3/16"	2-1/2"	0.12 lb	00005-SLT
00506-008*	-	1,124 lb	674 lb	25/32"	9/32"	3/16"	3-3/16"	0.19 lb	00005-SLT
00505-010	00505-010A	2,250 lb	1,350 lb	7/8"	3/8"	5/16"	3-3/8"	0.32 lb	00010-SLT, 00010-HEX
00505-015	00505-015A	3,500 lb	2,100 lb	1"	13/32"	3/8"	3-7/8"	0.51 lb	00015-SLT, 00015-HEX
00505-020	00505-020A	5,000 lb	3,000 lb	1-1/4"	17/32"	13/32"	4-3/4"	1.0 lb	00020-SLT, 00020-HEX
00505-025	00505-025A	7,000 lb	4,200 lb	1-3/8"	9/16"	1/2"	5-1/8"	1.4 lb	00025-SLT, 00025-HEX
00505-027	00505-027A	9,000 lb	5,400 lb	1-1/2"	19/32"	1/2"	5-5/8"	1.8 lb	00027-HEX
00505-030	00505-030A	10,000 lb	6,000 lb	1-5/8"	11/16"	5/8"	6"	2.1 lb	00030-SLT, 00030-HEX
00505-035	00505-035A	15,000 lb	9,000 lb	2"	25/32"	11/16"	7"	3.9 lb	00035-SLT, 00035-HEX
00505-040	00505-040A	25,000 lb	15,000 lb	2-3/8"	1-1/32"	7/8"	10-5/16"	8.2 lb	00040-HEX
00505-041**	-	30,000 lb	18,000 lb	2-3/8"	1-1/32"	7/8"	10-5/16"	8.3 lb	00040-HEX
00505-045**	-	50,000 lb	30,000 lb	3"	1-3/16"	1-1/8"	13-3/4"	18 lb	00045-HEX
00505-050**	-	62,500 lb	37,500 lb	3-3/4"	1-1/2"	1-1/4"	15-9/16"	34 lb	00050-HEX

\* This has a metric 3:1 Safe Working Load of 5 kN. Contact Customer Service for other metric equivalents.

\*\* These swivels are made from alloy steel with a black oxide finish; all others are stainless steel.

Note: Marine grade versions are available; made to order.

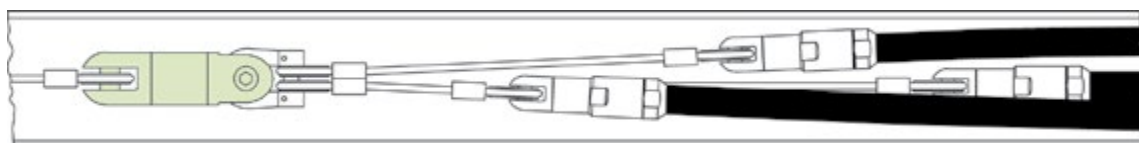

### Can-Link™ Connector

The Can-Link™ Connector is used to connect two items with lugs or wire loop fittings. A common use is to connect a wire mesh grip to the pulling wire. The connectors are manufactured from high strength stainless steel with hardened clevis pins.

The two smaller sizes have slotted clevis pins, while the larger sizes have hexagon clevis pins, all of which are available as spares (see page 11).

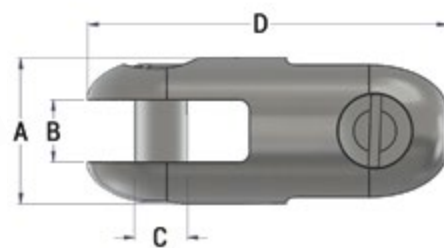

Part No.	3:1 Safe Working Load	A	B	C	D	Weight
00520-010	2,500 lb	7/8"	3/8"	5/16"	2-1/8"	0.17 lb
00520-020	5,000 lb	1-1/4"	17/32"	13/32"	2-7/8"	0.46 lb
00520-027	9,000 lb	1-1/2"	19/32"	1/2"	3-3/8"	0.73 lb
00520-035	15,000 lb	2"	25/32"	11/16"	4-9/16"	2.0 lb
00520-040	25,000 lb	2-13/32"	1"	7/8"	6-7/32"	4.0 lb

### Rope-to-Rope Connector

This product is used to connect two ropes of up to 7/8" dia. The entire product, including sheaves, is manufactured from stainless steel.

Replacement sheaves are available by contacting the customer service department. The sheaves run on standard DCD clevis pins, which are also available as spares (see page 11).

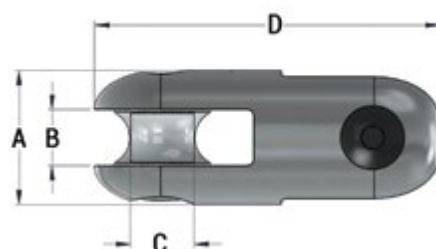

Part No.	3:1 Safe Working Load	Maximum Rope Diameter	A	B	C	D	Weight
00521-020	15,000 lb	5/8"	1-3/4"	3/4"	11/16"	4-7/8"	1.6 lb
00521-035	15,000 lb	7/8"	2"	15/16"	11/16"	5-1/2"	2.7 lb
00521-040	25,000 lb	7/8"	2-13/32"	1"	7/8"	6-7/32"	4.5 lb
00521-045	25,000 lb	1-3/8"	2-29/32"	1-13/32"	7/8"	8-13/32"	9.3 lb

### Rope-to-Swivel Connector

This product is used to connect a swivel to pulling rope. The entire product, including sheave, is manufactured from stainless steel.

Replacement sheaves are available by contacting Customer Service. The sheaves run on standard DCD clevis pins, which are also available as spares (see page 11).

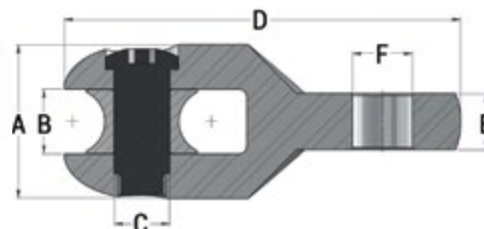

Part No.	3:1 Safe Working Load	Maximum Rope Diameter	A	B	C	D	E	F	Weight	Fits Line Swivel
00522-020	15,000 lb	5/8"	1-3/4"	3/4"	11/16"	4-7/8"	21/32"	3/4"	1.6 lb	00505-030 00505-035
00522-020A	15,000 lb	5/8"			Same as above without sheave				1.3 lb	
00522-025	7,000 lb	7/8"	2"	15/16"	11/16"	5-5/16"	1/2"	17/32"	2.1 lb	00505-020 00505-025 00505-027
00522-025A	7,000 lb	7/8"			Same as above without sheave				1.8 lb	
00522-035	15,000 lb	7/8"	2"	15/16"	11/16"	5-3/8"	21/32"	3/4"	2.3 lb	00505-030 00505-035
00522-035A	15,000 lb	7/8"			Same as above without sheave				2.0 lb	
00522-040	25,000 lb	7/8"	2-3/4"	1"	7/8"	6-7/32"	7/8"	15/16"	3.9 lb	00505-040
00522-040A	25,000 lb	7/8"			Same as above without sheave				3.6 lb	

## Wire Breakaway Connector

The Wire Breakaway Connector is our most recent addition to our family of breakaway connectors. This connector uses a wire instead of a pin to achieve the smallest of break loads. The two-piece design ensures you don't lose parts of your connector when separation does occur. The product is manufactured from stainless steel to provide years of service.

Originally designed to pull 1/2" medium density polyethylene or light duty fiber optic cable, our premier set of breakaway wires designed for this connector will break at different load capacities ensuring your product is protected from damage caused by over-pulling. Break loads from 15 to 200 lb are available.

Wire kits are sold separately in packs of 10.

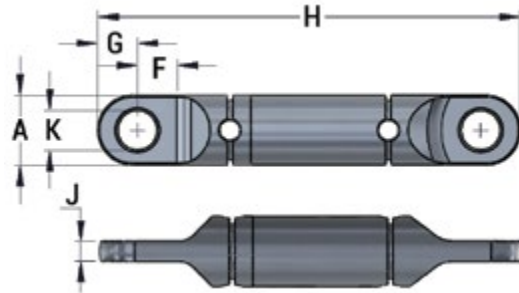

Part No.	A	B	C	D	E	F	G	H	J	K	Weight
00531-010	7/8"	-	-	-	-	1/2"	1/2"	5-11/32"	1/4"	1/2"	0.51 lb

Note: Marine grade versions are available; made to order.

## Wire Breakaway Swivel

This product is similar to our Wire Breakaway Connector (00531 series) as it protects the utility being installed from overload with the addition of a built-in swivel. Changing a wire takes just seconds.

Wire kits are sold separately in packs of 10.

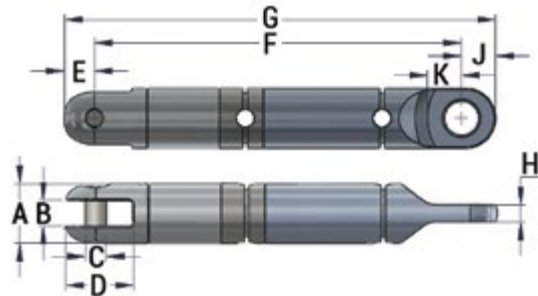
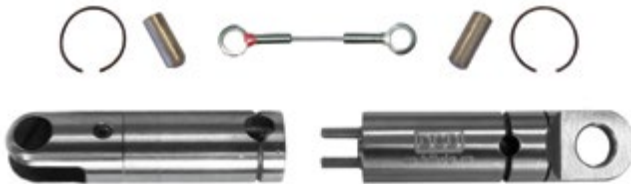

Part No.	A	B	C	D	E	F	G	H	J	K	Weight
00551-010	7/8"	3/8"	5/16"	31/32"	1/2"	5-3/8"	6-1/16"	1/4"	1/2"	1/2"	0.75 lb
00551-010S	7/8"	3/8"	5/16"	31/32"	1/2"	5-3/8"	6-1/16"	1/4"	1/2"	1/2"	0.75 lb

Note: S designates marine grade version.

## Breakaway Wire Kits

Metric and custom sizes are also available on request.

Part No. (10 wires/kit)	Breaking Point (+/- 10%)	Color Code
00536-022*	22 lb	Orange
00536-050	50 lb	Brown
00536-065	65 lb	Green
00536-080	80 lb	Purple
00536-100	100 lb	Red

\* This size has a breaking point of +/- 15%.

Part No. (10 wires/kit)	Breaking Point (+/- 10%)	Color Code
00536-120	120 lb	Blue
00536-140	140 lb	Turquoise
00536-185	185 lb	Pink
00536-200	200 lb	Gray
00536-KT1*	22 lb to 120 lb	Various

\* This is a Sampler Kit with three pins for each of the following: 00536-022, 00536-050, 00536-065, 00536-080, 00536-100, 00536-120.

## Min-E-Max™ Breakaway Connector

The purpose of this product is to protect the utility being installed from overload. Typically, they would be used during the installation of fiber optic cable where the connector can be preset to breakaway at a predetermined load, thus protecting the fibers or the duct. The breakaway pins may be changed to allow the same connector or to be used with a variety of different breakaway pins. Changing a pin takes just seconds.

Breakaway Pin Kits are sold separately in packs of 10.

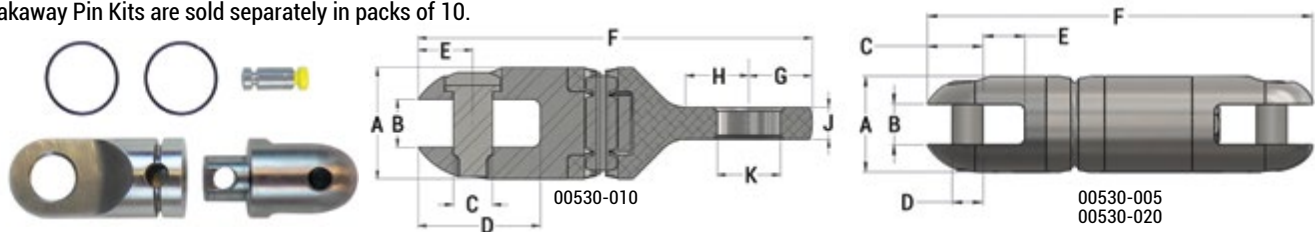

Part No.	A	B	C	D	E	F	G	H	J	K	Use Breakaway Pin Kits in	Weight
00530-005	5/8"	9/32"	7/32"	3/16"	9/32"	2-1/8"	-	-	-	-	Group A	0.10 lb
00530-010	7/8"	3/8"	5/16"	31/32"	7/16"	3-1/8"	1/2"	1/2"	1/4"	1/2"	Group B	0.25 lb
00530-020	1-1/4"	1/2"	3/4"	13/32"	9/16"	5-1/16"	-	-	-	-	Group C	1.03 lb

Note: Marine grade versions are available; made to order.

## Breakaway Swivel

This product is similar to our Breakaway Connector (00530 series) as it protects the utility being installed from overload with the addition of a built-in swivel. The breakaway pins may be changed to allow the same connector or to be used with a variety of different breakaway pins. Changing a pin takes just seconds.

Breakaway Pin Kits are sold separately in packs of 10.

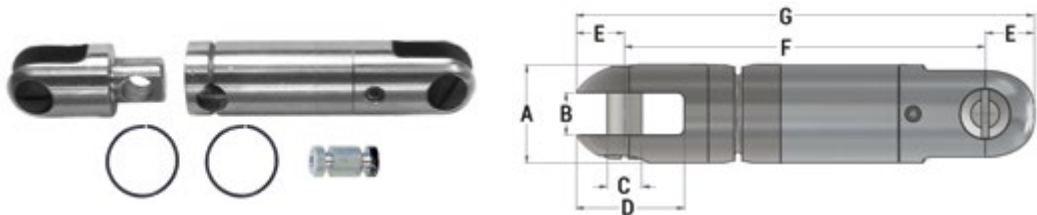

Part No.	A	B	C	D	E	F	G	Use Breakaway Pin Kits in	Weight
00550-005	5/8"	9/32"	3/16"	11/16"	1/4"	2-3/4"	3-1/4"	Group A	0.17 lb
00550-010	7/8"	3/8"	5/16"	31/32"	7/16"	3-3/16"	4-3/16"	Group B	0.42 lb
00550-020	1-1/4"	17/32"	13/32"	1-9/32"	17/32"	4-1/2"	5-9/16"	Group C	1.20 lb

Note: Marine grade versions are available; made to order.

## Breakaway Pin Kits

Metric sizing is also available, as requested.

### Group A

Part No. (10 pins/kit)	Breaking Point (+/- 10%)	Color Code
00555-00125*	125 lb	Green
00555-0015*	150 lb	Black
00555-002	200 lb	White
00555-003	300 lb	Purple
00555-0034	340 lb	Red
00555-004	400 lb	Yellow
00555-0045	450 lb	Blue
00555-006	600 lb	Orange
00555-007	675 lb	Black

### Group B

Part No. (10 pins/kit)	Breaking Point (+/- 10%)	Color Code
00535-002	200 lb	White
00535-004	400 lb	Yellow
00535-005	500 lb	Green
00535-006	600 lb	Orange
00535-006S	600 lb	Blue
00535-008	800 lb	Gray
00535-008S	800 lb	Black
00535-010	1,000 lb	Red

### Group C

Part No. (5 pins/kit)	Breaking Point (+/- 10%)	Color Code
00555-013	1,370 lb	White
00555-018	1,800 lb	Green
00555-020	2,000 lb	Blue
00555-027	2,700 lb	Black
00555-036	3,600 lb	Yellow
00555-040	4,000 lb	Red

US Patent # 5,122,007  
Canadian Patent # 2,109,849

\* Made to order.

## Heavy Duty Breakaway Connectors

These products are designed to protect polyethylene ducting from overload during installation by directional drilling and are used between the pullback swivel and the duct puller. The connectors are a three part product, held together by a group of pins. The pins are designed to break in tension at a specific load.

The assembly of the connector is completed by using one or more of the breakaway pins. The sum of the values of the pins is the value at which the connector will come apart. If a single 1,000 lb pin is used, the connector will come apart at 1,000 lb. If three pins of the same value were used, the connector would come apart at 3,000 lb. Different pin values can be mixed and matched to create a number of different values, all in the same connector. Metric pins are also available. See following pages for pin combinations.

The connectors are available in two sizes. The smaller unit covers values from 750 lb up to 12,500 lb (300 kg-6,000 kg) and the larger unit covers values from 3,000 lb up to 45,000 lb (2,000 kg-20,000 kg).

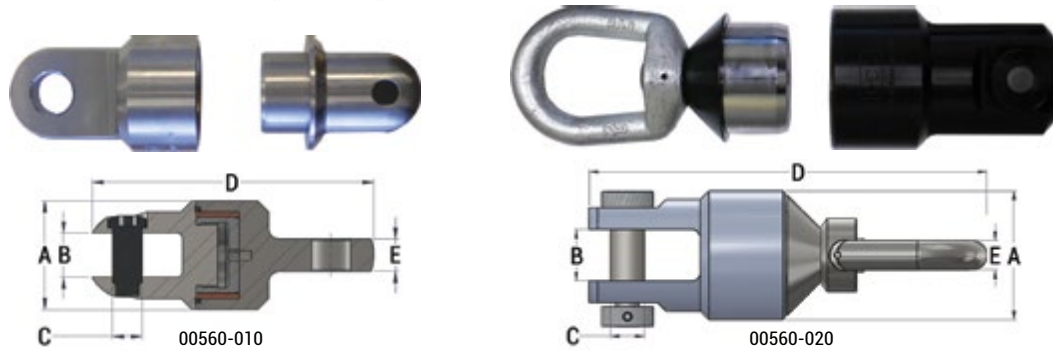

Connector Part No.	A	B	C	D	E	Weight	Replacement Clevis Pin Kit
00560-010	2-1/2"	1"	11/16"	6-1/2"	3/4"	4 lb	00035-HEX
00560-010S	2-1/2"	1"	11/16"	6-1/2"	3/4"	4 lb	00035-HEXS
00560-020	3-3/4"	1-1/2"	1"	12"	7/8"	15 lb	00508-P010
00560-020S	3-3/4"	1-1/2"	1"	12"	7/8"	15 lb	00508-P010S

Note: 'S' designates the connector as a marine grade stainless steel version, intended for use in a marine environment.

## HDD Breakaway Swivel

The HDD Breakaway Swivel is similar to our Heavy Duty Breakaway Connector (00560 series), but with a swivel included. Saving you space in your pullback assembly, the HDD Breakaway Swivel is only 1.5" longer than the 00503-208 Dub-Lite, meaning it's 5" shorter than the alternative of using the DUB-Lite and a Breakaway Connector together.

It will accept the same range of 00565 and 00566 breakaway pins that we offer, which gives the HDD Breakaway Swivel a break load range from 250 lb to 12,500 lb.

The 00570 series is uniquely designed for use in underground HDD applications. A sealed chamber protects the pin(s) from corrosion or damage from the environment. The pins are torqued into place, giving them resistance to fatigue and shock impact, which allows the HDD Breakaway Swivel to avoid premature separation. Seals are designed specifically for HDD environments, giving more longevity to the swivel.

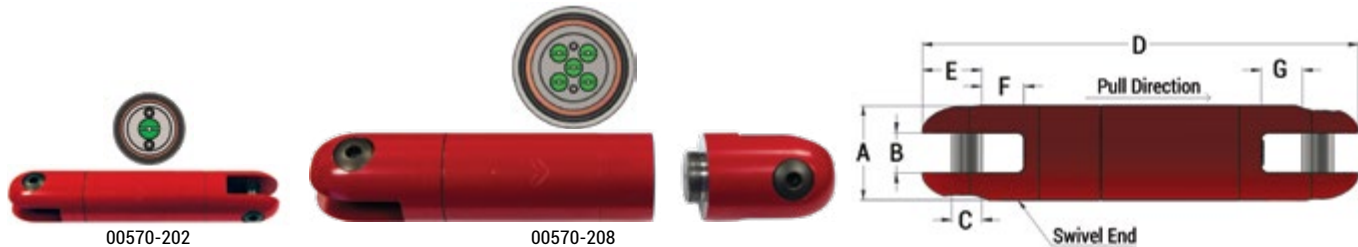

Part No.	Pin Capacity	A	B	C	D	E	F	G	Net Weight	Clevis Pin Kit	Rebuild Kit
00570-202	1 pin	1-1/4" 32 mm	1/2" 13 mm	13/32" 10 mm	5-3/4" 146 mm	3/4" 19 mm	1/2" 13 mm	9/16" 14 mm	1.1 lb 0.5 kg	00020-HEX	-
00570-208	5 pins	2-1/2" 64 mm	1" 25 mm	7/8" 22 mm	12-3/16" 309 mm	1-3/4" 44 mm	7/8" 22 mm	1" 25 mm	12.0 lb 5.5 kg	00040-HEX	00570-K08

## Breakaway Pin Kits

Originally, the DCD breakaway connectors were used by contractors installing gas ducting where it is critical to protect the duct from overload during installation. Many utilities now require the use of a breakaway connector to ensure the final integrity of the ducting.

Use of the breakaway connectors and swivels has expanded over the years to include fiber-optic pulling and line-stringing and has been incorporated into some innovative marine and vehicular towing applications. The versatility of this product is its main feature. It can easily be reset from one value to another allowing the same tool to be used for installation of many different duct sizes each requiring different load settings. To reduce fatigue, install the pin to the specified torque. The pin will not experience fatigue when the load is less than the preload value.

US Patent # 5,599,129  
Canadian Patent # 2,153,743



### 00565 Pin Kits (lb) for 00560-010 & 00570 Breakaways

Part No. (5 pins/kit)	Breaking Point (+/- 5%)	Color Code	Maximum Torque	Preload
00565-015*	150 lb	Black/Red	0.21 ft-lb	50 lb
00565-025*	250 lb	Brown	0.25 ft-lb	60 lb
00565-030*	300 lb	Black/Orange	0.33 ft-lb	80 lb
00565-040*	400 lb	Gray	0.54 ft-lb	130 lb
00565-070	700 lb	Green/Orange	1.8 ft-lb	420 lb
00565-075	750 lb	Yellow	2.3 ft-lb	540 lb
00565-100	1,000 lb	Orange	3.0 ft-lb	720 lb
00565-120	1,200 lb	Purple	3.3 ft-lb	800 lb
00565-130	1,300 lb	Black	3.5 ft-lb	840 lb
00565-150	1,500 lb	Red	4.1 ft-lb	980 lb
00565-200	2,000 lb	Blue	5.7 ft-lb	1,360 lb
00565-200S	2,000 lb	Gray/Yellow	5.7 ft-lb	1,360 lb
00565-250	2,500 lb	Green	7.1 ft-lb	1,700 lb
00565-250S	2,500 lb	Blue/Red	7.1 ft-lb	1,700 lb

\* This size has a breaking point of +/- 10%.

### 00566 Pin Kits (kg) for 00560-010 & 00570 Breakaways

Part No. (5 pins/kit)	Breaking Point (+/- 5%)	Color Code	Maximum Torque	Preload
00566-030	300 kg	White	2.71 Nm	199 kg
00566-040	400 kg	Beige/Green	4.07 Nm	272 kg
00566-050	500 kg	Turquoise	4.07 Nm	335 kg
00566-100	1,000 kg	Purple/Orange	8.13 Nm	635 kg
00566-120	1,200 kg	Black/White	9.49 Nm	743 kg



### 00565 Pin Kits (lb) for 00560-020 Breakaways

Part No. (5 pins/kit)	Breaking Point (+/- 5%)	Color Code	Maximum Torque	Preload
00565-300	3,000 lb	Yellow	12 ft-lb	1,853 lb
00565-300S	3,000 lb	Brown	12 ft-lb	1,853 lb
00565-600	6,000 lb	Orange	26 ft-lb	3,680 lb
00565-700	7,000 lb	Red	30 ft-lb	4,160 lb
00565-800	8,000 lb	Blue	33 ft-lb	4,800 lb
00565-900	9,000 lb	Green	33 ft-lb	5,280 lb

Note: 'S' designates a marine grade version.

### 00566 Pin Kits (kg) for 00560-020 Breakaways

Part No. (5 pins/kit)	Breaking Point (+/- 5%)	Color Code	Maximum Torque	Preload
00566-200	2,000 kg	White	24.40 Nm	1,306 kg
00566-250	2,500 kg	Beige	31.18 Nm	1,669 kg
00566-300	3,000 kg	Turquoise	35.25 Nm	1,886 kg
00566-350	3,500 kg	Purple	37.96 Nm	2,032 kg
00566-400	4,000 kg	Black	42.03 Nm	2,249 kg

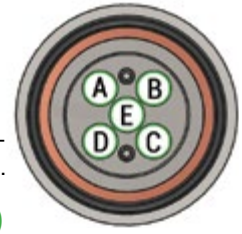

## Breakaway Pin Configuration Options for 00560-010 & 00570-208

The following tables are suggested ways of arriving at required load values. Other combinations are also possible, depending on the connector and pins. The 00560-010 and 00570-208 have 5 pin locations designated as A to E (see diagram).

### Using 00565 Series Pins (lb)

Pin Location (See Diagram)					
A	B	C	D	E	Break Value
-	-	-	-	750	<b>750</b>
-	-	-	-	1,000	<b>1,000</b>
-	-	-	-	1,500	<b>1,500</b>
1,000	-	750	-	-	<b>1,750</b>
-	-	-	-	2,000	<b>2,000</b>
750	-	750	-	750	<b>2,250</b>
750	-	750	-	1,000	<b>2,500</b>
1,000	-	1,000	-	750	<b>2,750</b>
750	750	750	750	-	<b>3,000</b>
750	750	750	1,000	-	<b>3,250</b>
750	1,000	750	1,000	-	<b>3,500</b>
1,500	-	1,500	-	750	<b>3,750</b>
1,000	1,000	1,000	1,000	-	<b>4,000</b>
1,000	750	1,000	750	750	<b>4,250</b>
1,500	-	1,500	-	1,500	<b>4,500</b>
2,000	-	2,000	-	750	<b>4,750</b>
-	2,500	-	2,500	-	<b>5,000</b>
1,500	750	1,500	750	750	<b>5,250</b>
2,000	-	2,000	-	1,500	<b>5,500</b>
1,000	1,500	1,000	1,500	750	<b>5,750</b>
1,500	1,500	1,500	1,500	-	<b>6,000</b>
2,000	750	2,000	750	750	<b>6,250</b>
1,500	750	1,500	750	2,000	<b>6,500</b>
1,500	1,500	1,500	1,500	750	<b>6,750</b>
1,500	2,000	1,500	2,000	-	<b>7,000</b>
2,000	1,000	2,000	1,500	750	<b>7,250</b>
-	2,500	-	2,500	2,500	<b>7,500</b>
2,000	1,500	2,000	1,500	750	<b>7,750</b>
2,000	2,000	2,000	2,000	-	<b>8,000</b>
2,000	1,500	2,000	1,500	1,500	<b>8,500</b>
1,500	2,000	1,500	2,000	2,000	<b>9,000</b>
2,000	2,000	2,000	2,000	1,500	<b>9,500</b>
2,500	2,500	2,500	2,500	-	<b>10,000</b>
2,500	2,000	2,500	2,000	1,500	<b>10,500</b>
2,500	2,500	2,500	2,500	1,000	<b>11,000</b>
2,500	2,500	2,500	2,500	1,500	<b>11,500</b>
2,500	2,500	2,500	2,500	2,000	<b>12,000</b>
2,500	2,500	2,500	2,500	2,500	<b>12,500</b>

### Using 00566 Series Pins (kg)

Pin Location (See Diagram)					
A	B	C	D	E	Break Value
-	-	-	-	300	<b>300</b>
-	-	-	-	400	<b>400</b>
-	-	-	-	500	<b>500</b>
300	-	300	-	-	<b>600</b>
300	-	400	-	-	<b>700</b>
400	-	400	-	-	<b>800</b>
400	-	500	-	-	<b>900</b>
-	-	-	-	1,000	<b>1,000</b>
400	-	400	-	300	<b>1,100</b>
400	-	400	-	400	<b>1,200</b>
400	-	400	-	500	<b>1,300</b>
500	-	500	-	400	<b>1,400</b>
500	-	500	-	500	<b>1,500</b>
300	-	300	-	1,000	<b>1,600</b>
500	400	500	300	-	<b>1,700</b>
400	-	400	-	1,000	<b>1,800</b>
500	500	500	400	-	<b>1,900</b>
1,000	-	1,000	-	-	<b>2,000</b>
500	400	500	400	300	<b>2,100</b>
500	400	500	400	400	<b>2,200</b>
500	400	500	400	500	<b>2,300</b>
1,200	-	1,200	-	-	<b>2,400</b>
500	500	500	500	500	<b>2,500</b>
1,000	300	1,000	300	-	<b>2,600</b>
1,200	-	1,200	-	300	<b>2,700</b>
1,200	-	1,200	-	400	<b>2,800</b>
1,200	-	1,200	-	500	<b>2,900</b>
1,000	-	1,000	-	1,000	<b>3,000</b>
1,000	400	1,000	400	300	<b>3,100</b>
1,000	400	1,000	400	400	<b>3,200</b>
1,000	400	1,000	400	500	<b>3,300</b>
1,200	-	1,200	-	1,000	<b>3,400</b>
1,200	400	1,200	400	300	<b>3,500</b>
1,200	-	1,200	-	1,200	<b>3,600</b>
1,200	400	1,200	400	500	<b>3,700</b>
1,000	400	1,000	400	1,000	<b>3,800</b>
1,200	500	500	500	500	<b>3,900</b>
1,000	1,000	1,000	1,000	-	<b>4,000</b>
1,000	400	1,000	500	1,200	<b>4,100</b>
1,200	400	1,200	400	1,000	<b>4,200</b>
1,000	1,000	1,000	1,000	300	<b>4,300</b>
1,000	1,000	1,000	1,000	400	<b>4,400</b>
1,000	1,000	1,000	1,000	500	<b>4,500</b>
1,200	500	1,200	500	1,200	<b>4,600</b>
1,000	1,200	1,000	1,200	300	<b>4,700</b>
1,200	1,200	1,200	1,200	-	<b>4,800</b>
1,000	1,200	1,000	1,200	500	<b>4,900</b>
1,000	1,000	1,000	1,000	1,000	<b>5,000</b>
1,200	1,200	1,200	1,200	300	<b>5,100</b>
1,200	1,200	1,200	1,200	400	<b>5,200</b>
1,200	1,200	1,200	1,200	500	<b>5,300</b>
1,200	1,000	1,200	1,000	1,000	<b>5,400</b>
1,200	1,000	1,200	1,000	1,200	<b>5,600</b>
1,200	1,200	1,200	1,200	1,000	<b>5,800</b>
1,200	1,200	1,200	1,200	1,200	<b>6,000</b>

Note: Uneven pin distribution may result in up to 10% lower breaking point.



### Breakaway Pin Configuration Options for 00560-020

The following tables are suggested ways of arriving at required load values. Other combinations are also possible, depending on the pins. The 00560-020 has 5 pin locations designated as A to E (see diagram on opposite page).

#### Using 00565 Series Pins (lb)

Pin Location (See Diagram on Page 18)					
A	B	C	D	E	Break Value
-	-	-	-	3,000	<b>3,000</b>
3,000	-	3,000	-	-	<b>6,000</b>
3,000	-	3,000	-	3,000	<b>9,000</b>
6,000	-	6,000	-	-	<b>12,000</b>
3,000	-	3,000	-	7,000	<b>13,000</b>
7,000	-	7,000	-	-	<b>14,000</b>
3,000	-	3,000	-	9,000	<b>15,000</b>
8,000	-	8,000	-	-	<b>16,000</b>
7,000	-	7,000	-	3,000	<b>17,000</b>
9,000	-	9,000	-	-	<b>18,000</b>
8,000	-	8,000	-	3,000	<b>19,000</b>
7,000	-	7,000	-	6,000	<b>20,000</b>
7,000	-	7,000	-	7,000	<b>21,000</b>
7,000	-	7,000	-	8,000	<b>22,000</b>
7,000	-	7,000	-	9,000	<b>23,000</b>
8,000	-	8,000	-	8,000	<b>24,000</b>
8,000	-	8,000	-	9,000	<b>25,000</b>
9,000	-	9,000	-	8,000	<b>26,000</b>
9,000	-	9,000	-	9,000	<b>27,000</b>
7,000	7,000	7,000	7,000	-	<b>28,000</b>
3,000	7,000	3,000	7,000	9,000	<b>29,000</b>
6,000	6,000	6,000	6,000	6,000	<b>30,000</b>
6,000	6,000	6,000	6,000	7,000	<b>31,000</b>
6,000	6,000	6,000	6,000	8,000	<b>32,000</b>
6,000	6,000	6,000	6,000	9,000	<b>33,000</b>
7,000	7,000	7,000	7,000	6,000	<b>34,000</b>
7,000	7,000	7,000	7,000	7,000	<b>35,000</b>
7,000	7,000	7,000	7,000	8,000	<b>36,000</b>
7,000	7,000	7,000	7,000	9,000	<b>37,000</b>
8,000	7,000	8,000	7,000	8,000	<b>38,000</b>
8,000	7,000	8,000	7,000	9,000	<b>39,000</b>
8,000	8,000	8,000	8,000	8,000	<b>40,000</b>
8,000	8,000	8,000	8,000	9,000	<b>41,000</b>
9,000	9,000	9,000	9,000	6,000	<b>42,000</b>
9,000	9,000	9,000	9,000	7,000	<b>43,000</b>
9,000	9,000	9,000	9,000	8,000	<b>44,000</b>
9,000	9,000	9,000	9,000	9,000	<b>45,000</b>

Note: Uneven pin distribution may result in up to 10% lower breaking point.

#### Using 00566 Series Pins (kg)

Pin Location (See Diagram on Page 18)					
A	B	C	D	E	Break Value
-	-	-	-	2,000	<b>2,000</b>
-	-	-	-	3,000	<b>3,000</b>
2,000	-	2,000	-	-	<b>4,000</b>
2,500	-	2,500	-	-	<b>5,000</b>
3,000	-	3,000	-	-	<b>6,000</b>
2,000	-	2,000	-	2,500	<b>6,500</b>
2,000	-	2,000	-	3,000	<b>7,000</b>
2,000	-	2,000	-	3,500	<b>7,500</b>
4,000	-	4,000	-	-	<b>8,000</b>
3,000	-	3,000	-	2,500	<b>8,500</b>
3,000	-	3,000	-	3,000	<b>9,000</b>
3,000	-	3,000	-	3,500	<b>9,500</b>
3,000	-	3,000	-	4,000	<b>10,000</b>
4,000	-	4,000	-	2,500	<b>10,500</b>
4,000	-	4,000	-	3,000	<b>11,000</b>
4,000	-	4,000	-	3,500	<b>11,500</b>
4,000	-	4,000	-	4,000	<b>12,000</b>
2,500	2,500	2,500	2,500	2,500	<b>12,500</b>
2,500	2,500	2,500	2,500	3,000	<b>13,000</b>
2,500	2,500	2,500	2,500	3,500	<b>13,500</b>
2,500	2,500	2,500	2,500	4,000	<b>14,000</b>
3,000	3,000	3,000	3,000	2,500	<b>14,500</b>
3,000	3,000	3,000	3,000	3,000	<b>15,000</b>
3,000	3,000	3,000	3,000	3,500	<b>15,500</b>
3,000	3,000	3,000	3,000	4,000	<b>16,000</b>
3,000	3,500	3,000	3,500	3,500	<b>16,500</b>
3,500	3,500	3,500	3,500	3,000	<b>17,000</b>
3,500	3,500	3,500	3,500	3,500	<b>17,500</b>
3,500	3,500	3,500	3,500	4,000	<b>18,000</b>
4,000	3,500	4,000	3,500	3,500	<b>18,500</b>
4,000	3,500	4,000	3,500	4,000	<b>19,000</b>
4,000	4,000	4,000	4,000	3,500	<b>19,500</b>
4,000	4,000	4,000	4,000	4,000	<b>20,000</b>

## Marine Grade Heavy Duty Breakaway Connector

As the name suggests, this heavy-duty breakaway connector is built with marine grade stainless steel (as designated by the 'S' in the part no.) and is intended as mechanical overload protection for marine applications, such as when installing cable, ducting, or pipe. It uses a new, larger set of breakaway pins (00575 Series) and has a total of 17 pin locations, allowing for a break load range from 4,700 lb to 79,900 lb.

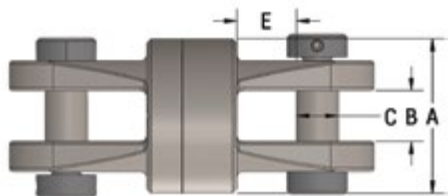
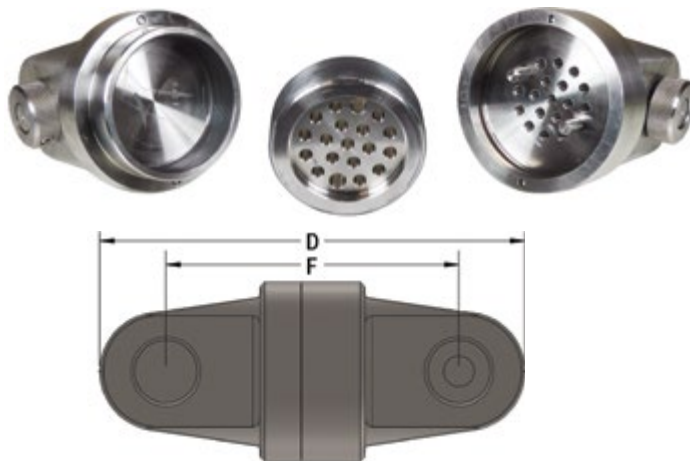

Part No.	A	B	C	D	E	F	Weight	Replacement Clevis Pin Kit
<b>00560-280S</b>	6-1/2"	2-1/8"	1-3/4"	15-5/16"	2-1/2"	10-9/16"	76 lb	<b>00508-040S</b>

Note: Non-marine grade version is available upon request (Part No. 00560-280).



## 00575 Breakaway Pin Kit (lb)

Part No. (14 pins/kit)	Breaking Point (+/- 5%)	Color Code	Maximum Torque	Preload
<b>00575-470</b>	4,700 lb	Blue	13 ft-lb	2,800 lb

Note: Other pin kits with different breaking points are available upon request.

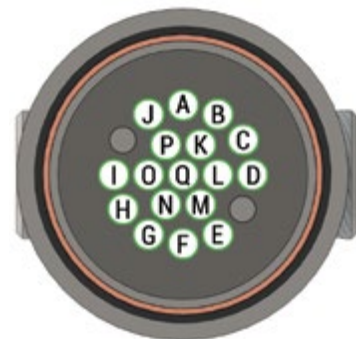

## Breakaway Pin Configuration Options for 00560-280S

The following table provides several suggestions for different pin configurations in the 00560-280S Breakaway Connector and the ultimate break value that will result from each one. With 17 potential pin locations, it is important to balance the pins in a particular way. These values are all achievable with a set of 00575-040 pins, but other pin kits with different break values are available upon request.

Pin Location (See Diagram)																	Break Value	
A	B	C	D	E	F	G	H	I	J	K	L	M	N	O	P	Q		
-	-	-	-	-	-	-	-	-	-	-	-	-	-	-	-	-	4,700	<b>4,700</b>
-	-	-	-	-	-	-	-	-	-	4,700	-	-	4,700	-	-	-	-	<b>9,400</b>
-	-	-	-	-	-	-	-	-	-	4,700	-	4,700	-	4,700	-	-	-	<b>14,100</b>
-	-	-	-	-	-	-	-	-	-	4,700	-	4,700	4,700	-	4,700	-	-	<b>18,800</b>
-	-	-	-	-	-	-	-	-	-	4,700	-	4,700	4,700	4,700	-	4,700	4,700	<b>23,500</b>
-	-	-	-	-	-	-	-	-	-	4,700	4,700	4,700	4,700	4,700	4,700	4,700	-	<b>28,200</b>
-	-	-	-	-	-	-	-	-	-	4,700	4,700	4,700	4,700	4,700	4,700	4,700	4,700	<b>32,900</b>
4,700	-	-	-	-	-	-	-	-	-	4,700	4,700	4,700	4,700	4,700	4,700	4,700	4,700	<b>37,600</b>
4,700	-	-	-	-	4,700	-	-	-	-	4,700	4,700	4,700	4,700	4,700	4,700	4,700	4,700	<b>42,300</b>
-	-	-	4,700	-	-	4,700	-	-	4,700	4,700	4,700	4,700	4,700	4,700	4,700	4,700	4,700	<b>47,000</b>
4,700	-	-	4,700	-	4,700	-	-	4,700	-	4,700	4,700	4,700	4,700	4,700	4,700	4,700	4,700	<b>51,700</b>
4,700	-	4,700	-	4,700	-	4,700	-	4,700	-	4,700	4,700	4,700	4,700	4,700	4,700	4,700	4,700	<b>56,400</b>
-	4,700	-	4,700	4,700	-	4,700	-	4,700	4,700	4,700	4,700	4,700	4,700	4,700	4,700	4,700	4,700	<b>61,100</b>
-	4,700	-	4,700	4,700	4,700	-	4,700	4,700	4,700	4,700	4,700	4,700	4,700	4,700	4,700	4,700	4,700	<b>65,800</b>
4,700	4,700	-	4,700	4,700	4,700	-	4,700	4,700	4,700	4,700	4,700	4,700	4,700	4,700	4,700	4,700	4,700	<b>70,500</b>
4,700	4,700	-	4,700	4,700	4,700	4,700	4,700	4,700	4,700	4,700	4,700	4,700	4,700	4,700	4,700	4,700	4,700	<b>75,200</b>
4,700	4,700	4,700	4,700	4,700	4,700	4,700	4,700	4,700	4,700	4,700	4,700	4,700	4,700	4,700	4,700	4,700	4,700	<b>79,900</b>

Note: Uneven pin distribution may result in up to 10% lower breaking point.

## Magnetic Breakaway Connector

The Magnetic Breakaway Connector is intended as mechanical overload protection for use in low force applications where accuracy and repeatability are required. The connector is intended to be suitable for long term use, where fatigue of traditional mechanical fuses needs to be eliminated, and easy, quick, inexpensive reset of the connector is required. It is used in conjunction with 00537 Series breakaway magnet kits.



Part No.	Separation Load Range	A	B	C	D	Weight	Replacement Clevis Pin Kit
00540-010	50 lb to 80 lb	6-1/2"	2-1/8"	1-3/4"	15-5/16"	2.88 lb	00035-SLT, 00035-HEX

## Magnet Kits for 00540-010 Magnetic Breakaway Connector

The 00540-010 Magnetic Breakaway Connector uses neodymium disc magnets that are available in three different color-coded kits to allow a range of separation loads.



Part No.	Nominal Failure Load	Minimum Failure Load	Maximum Failure Load	Magnets Per Kit	A	B	Color Code	Net Kit Weight
00537-050R*	50 lb per kit	40 lb	60 lb	3	3/8"	3/4"	Blue	0.08 lb
00537-060	60 lb per kit	48 lb	72 lb	7	1/2"	1/2"	Green	0.08 lb
00537-080	80 lb per kit	64 lb	96 lb	7	1/2"	1/2"	Purple	0.08 lb

Note: The magnets are designed to separate within +/- 20% of their nominal failure load.

\* This magnet is coated in a durable layer of rubber.

## Industries serviced by DCD Breakaway products

Our extensive lineup of Breakaway products, ranging from connectors to swivels and utilizing various separation materials, from pins to wires to magnets, services many different industries, including the following:



For more information on our Breakaway products, visit our website at [www.breakawayconnector.com](http://www.breakawayconnector.com).

## Eye to Eye/Clevis Connectors

These connectors are used for many applications. The two halves will not rotate under load, but are useful for aligning products. They are forged from carbon steel and galvanized for protection.



Eye to Eye Part No.	Eye to Clevis Part No.	Nominal Size	5:1 Safe Working Load	Weight
00652-037	00653-037	3/8"	2,250 lb	0.70 lb
00652-050	00653-050	1/2"	3,600 lb	1.36 lb
00652-062	00653-062	5/8"	5,200 lb	2.47 lb
00652-075	-	3/4"	7,200 lb	3.75 lb

## Connecting Shackles

These shackles provide a low cost, economical means of connecting two products together. They are available in two types: one with a bolt, nut and cotter pin for locking (00654 series), the other with a one piece bolt with a flanged head suitable for wire locking if needed (00655 series).

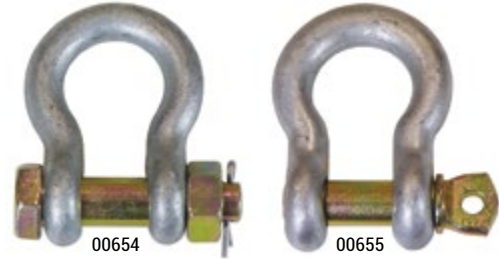

Part No.	Part No.	Nominal Size	6:1 Safe Working Load	Weight
-	00655-018	3/16"	1/3 ton	0.06 lb
-	00655-025	1/4"	1/2 ton	0.11 lb
00654-031	00655-031	5/16"	3/4 ton	0.18 lb
00654-037	00655-037	3/8"	1 ton	0.31 lb
00654-043	00655-043	7/16"	1-1/2 ton	0.43 lb
00654-050	00655-050	1/2"	2 ton	0.68 lb
00654-062	00655-062	5/8"	3-1/4 ton	1.33 lb
-	00655-075	3/4"	4-3/4 ton	2.22 lb
-	00655-087	7/8"	6-1/2 ton	3.39 lb
-	00655-100	1"	8-1/2 ton	4.92 lb
-	00655-112	1-1/8"	9-1/2 ton	7.63 lb
-	00655-125	1-1/4"	12 ton	10.30 lb
-	00655-137	1-3/8"	13-1/2 ton	13.65 lb
-	00655-150	1-1/2"	17 ton	17.90 lb
-	00655-175	1-3/4"	25 ton	29.29 lb
-	00655-200	2"	35 ton	44.00 lb

## Chain-Link Connector

These Chain-Link Connectors are useful and easy to insert in any pulling line. They allow easier bending of a pulling eye or other rigid component when going around bends or sheaves. These high quality products are manufactured with grade 80 steel.



Part No.	Nominal Size	3:1 Safe Working Load	Weight
00656-028	9/32"	4,650 lb	0.29 lb
00656-037	3/8"	9,450 lb	0.77 lb
00656-050	1/2"	16,000 lb	1.59 lb
00656-062	5/8"	24,100 lb	3.13 lb

## Quick Link Connector

The Quick Link Connector can be used in a variety of applications to connect a number of our products to each other. They provide low cost, ease of use, and no maintenance.



Part No.	Nominal Size	2:1 Safe Working Load	Loop Inside Width	Overall Outside Length	Weight
00660-187	3/16"	660 lb	1/2"	2"	0.05 lb
00660-250	1/4"	880 lb	1/2"	2-3/8"	0.08 lb
00660-312	5/16"	1,760 lb	5/8"	3"	0.17 lb
00660-375	3/8"	2,200 lb	11/16"	3-3/16"	0.23 lb
00660-437	7/16"	2,600 lb	3/4"	3-1/2"	0.31 lb
00660-500	1/2"	3,300 lb	7/8"	4-1/8"	0.51 lb

## Wire Rope Bridle Sling

The purpose of this product is to allow multiple pulls at one time by attaching two, three, or four cables or ducts to the puller. The slings are manufactured from aircraft quality wire rope with thimble eyes for durability (tapered swages are also available). The various "legs" are staggered in length so the individual connections are not interfering with each other. The lead coupler can be easily dismantled to change out a leg or to add another leg.

Each leg is marked with load capacity and they have a three times safety factor on that rating. The safety factor is based on equal pull on all cables (horizontal pull only). Couplers and wire rope sling legs may be ordered separately. Other sling configurations are available upon request.

DUB-Lite (00503 series) or Line Swivels (00505 series) are recommended to permit free rotation of the bridle at the legs and coupler. The recommended swivels are sized to suit the load and connection: smaller swivels over the leg loop, a larger swivel to fit the shackle.

Note: Custom lengths and configurations (including 5 & 6-leg versions) are available upon request.



Part No.	Wire Diameter	No. of Legs	3:1 Safe Working Load		Weight	Recommended DUB-Lite		Recommended Line Swivel	
			Leg Capacity	Sling Capacity		Over Shackle	Over Leg Loop	Over Shackle	Over Leg Loop
23125-020	1/8"	2	650 lb	1,300 lb	0.5 lb	00503-202 00503-204 00503-205	00503-202	00505-020	00505-005
23125-030	1/8"	3	650 lb	1,950 lb	0.6 lb			00505-025	00505-010
23125-040	1/8"	4	650 lb	2,600 lb	0.6 lb			00505-027	00505-015
23250-020	1/4"	2	2,300 lb	4,600 lb	1.2 lb	00503-204 00503-205 00503-208 00503-210	00503-202	00505-027	00505-010
23250-030	1/4"	3	2,300 lb	6,900 lb	1.6 lb			00505-030	00505-015
23250-040	1/4"	4	2,300 lb	7,100 lb	2.0 lb			00505-035	00505-020 00505-025
23375-020	3/8"	2	4,800 lb	9,600 lb	2.9 lb	00503-208* 00503-210* 00503-215	00503-204 00503-205 00503-208 00503-210	00505-035†	00505-020
23375-030	3/8"	3	4,800 lb	12,000 lb	3.7 lb			00505-040	00505-025
23375-040	3/8"	4	4,800 lb	18,000 lb	5.9 lb			00505-041	00505-027 00505-030
23500-020	1/2"	2	6,900 lb	13,800 lb	6.7 lb	00503-215	00503-204** 00503-205 00503-208 00503-210	00505-040	00505-030
23500-030	1/2"	3	6,900 lb	20,700 lb	8.6 lb			00505-041	00505-035
23500-040	1/2"	4	6,900 lb	28,300 lb	12.7 lb			00505-045 00505-050	

\* These DUB-Lites do not fit the 23375-040.

\*\* These DUB-Lites do not fit the 23500-040.

† These Line Swivels do not fit the 23375-040.

