

SMP-RP-27HD

Fixed Width Cable Reel Roller System



The SMP-RP-27HD reel roller system is ideal for storage, dispensing and management solutions of cable reels ranging from 12" to 48" in diameter. The SMP-RP-27HD can accommodate cable drums up to 27" wide with weights up to 3,000 pounds. The seven (7) gauge steel frames include six (6) position adjustments for the rollers, a slanted loading ramp, front roller locks for easy loading & unloading, and pre-drilled holes for permanent mounting applications.

Features:

- One (1) SMP-RP-27HD per reel (reel sold separately)
- 3,000 lbs. capacity per system
- Product weight: 67 lbs. each
- Maximum reel width: 27" (68.5 cm)
- Maximum reel diameter: 48" (122 cm)
- Hex bore ball bearing reel rollers
- Powder coated finish
- Six (6) position roller adjustment
- Frames constructed of 7-gauge steel bolted together
- Slanted loading ramp & front roller lock for loading/unloading
- Pre-drilled base for bolt-down installation
- Outside roller dimensions: 4.5" H x 34" W x 29.5" D



Accessories for SMP-RP-27HD Reel Roller Systems

Compatible with the optional SMP-ASA Arbor Support Assembly

The SMP-ASA mounts on the outside of the reel roller to prevent dislodging of cable reels, requires a 1.5" pipe (not included). One (1) SMP-ASA set includes two (2) supports for one (1) SMP-RP-27HD.



P.O. Box 12017 Marina del Rey, CA 90292
Phone: 310-822-6290 Fax: 310-306-9343
Email: info@spoolmaster.com
Visit us online at www.spoolmaster.com



SMP-RP-27HD

Fixed Width Cable Reel Roller System

Dimensions Per Roller:

Length:	29.5" (75 cm)
Width:	33.5" (85 cm)
Depth:	4.5" (11.5 cm)
Weight:	67 lbs (16.8 kg)
Ramp (Depth):	8" (20.3 cm)
Ramp (Width):	29" (73.7 cm)

Distance Between Center Points on Rollers:

Position 1:	9.5" (24 cm)
Position 2:	11" (28 cm)
Position 3:	12.5" (32 cm)
Position 4:	14.25" (36 cm)
Position 5:	15.75" (40 cm)
Position 6:	17.5" (44 cm)

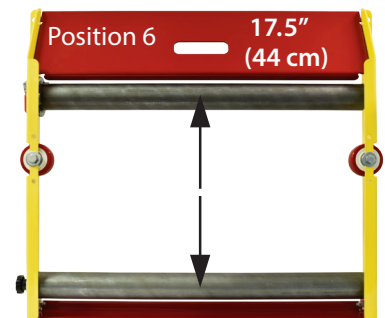
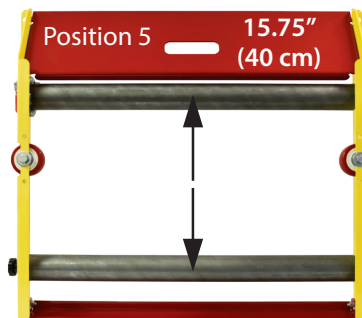
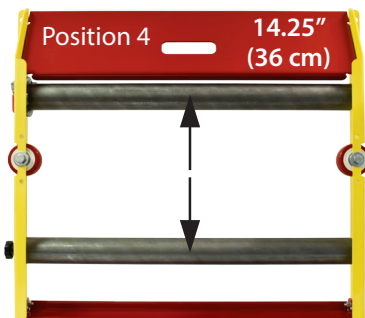
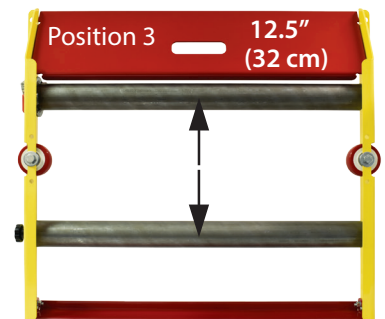
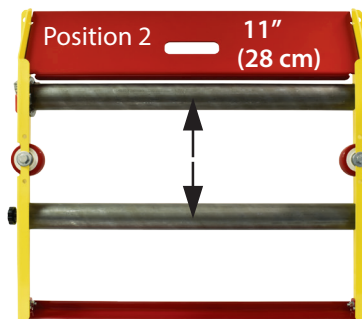
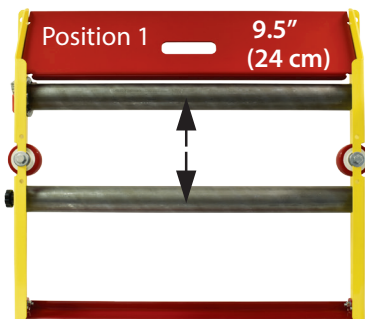
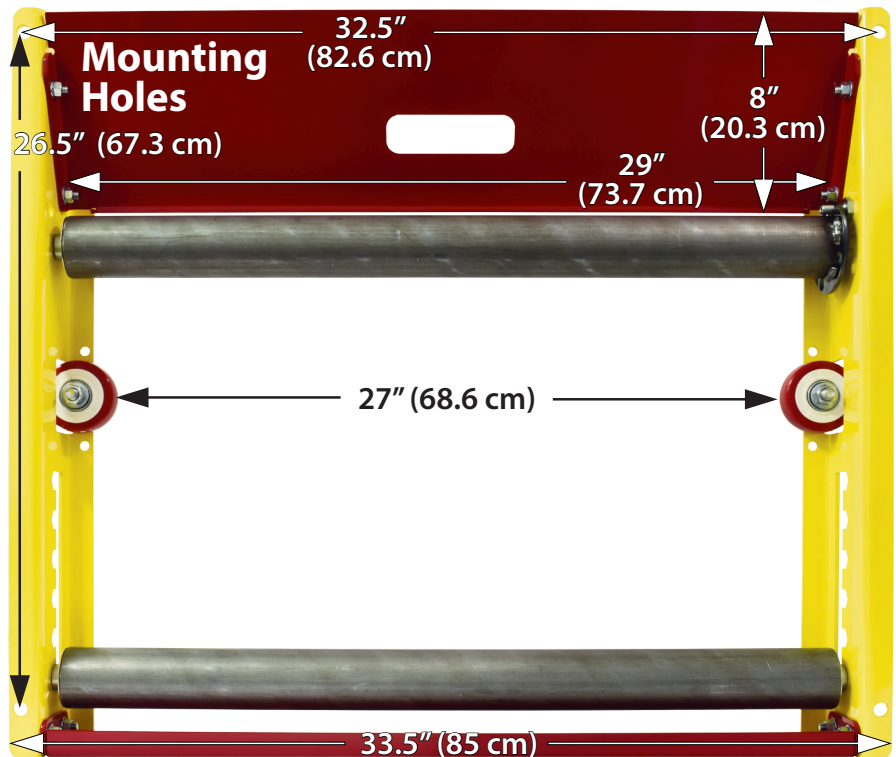

P.O. Box 12017 Marina del Rey, CA 90292
Phone: 310-822-6290 Fax: 310-306-9343
Email: info@spoolmaster.com
Visit us online at www.spoolmaster.com

